



STRATOCASTER

DIY GUITAR KIT

Joint: Bolt-on
Body: Basswood
Neck: Maple
Fingerboard: Rosewood
Tuning Machines: Chrome Die-cast
Scale Length: 25.5"
Fret: 22
Control: 1V, 2T, 5-Way Selector
Pickups: S-S-S
Hardware: Chrome
Bridge: Tremolo
Pickguard: 3-Ply White Pickguard



Assembly Instructions

Please read these instructions carefully before beginning to build your guitar in order to have a complete overview of the project. There are five steps that you will need to follow to complete your Electric Guitar Kit.

1. Check and Identify Parts
2. Finishing the Body and Neck
3. Shaping the Headstock
4. Assembling the Guitar
5. Setup

Following is the list of parts that are included with your kit. If parts are lost or run through the stump shredder during assembly you may order replacements from your local music shop or directly from us.

Quantity Description

	Quantity	Description
A	1	Ash Body
B	1	Maple Neck, Rosewood Fingerboard
C	1	Chrome Output Jack
D	1	3 Ply Pickguard Assembly
E	1	Chrome Tremolo Unit
F	1	Chrome Tremolo Arm with white tip
G	1	Spring Claw
H		Set of 3 Springs
I	1	White Back Plate
J		Set of 6 Chrome Tuning Machines
K		Set of 2 Strings Tees
L	1	Chrome Neck Plate and neck plate pad
M		Set of 6 Strings (.09 - .42)
N	1	2m Guitar Lead
O	2	Chrome Strap Buttons, Screws and Rubber Pads

(See next page)

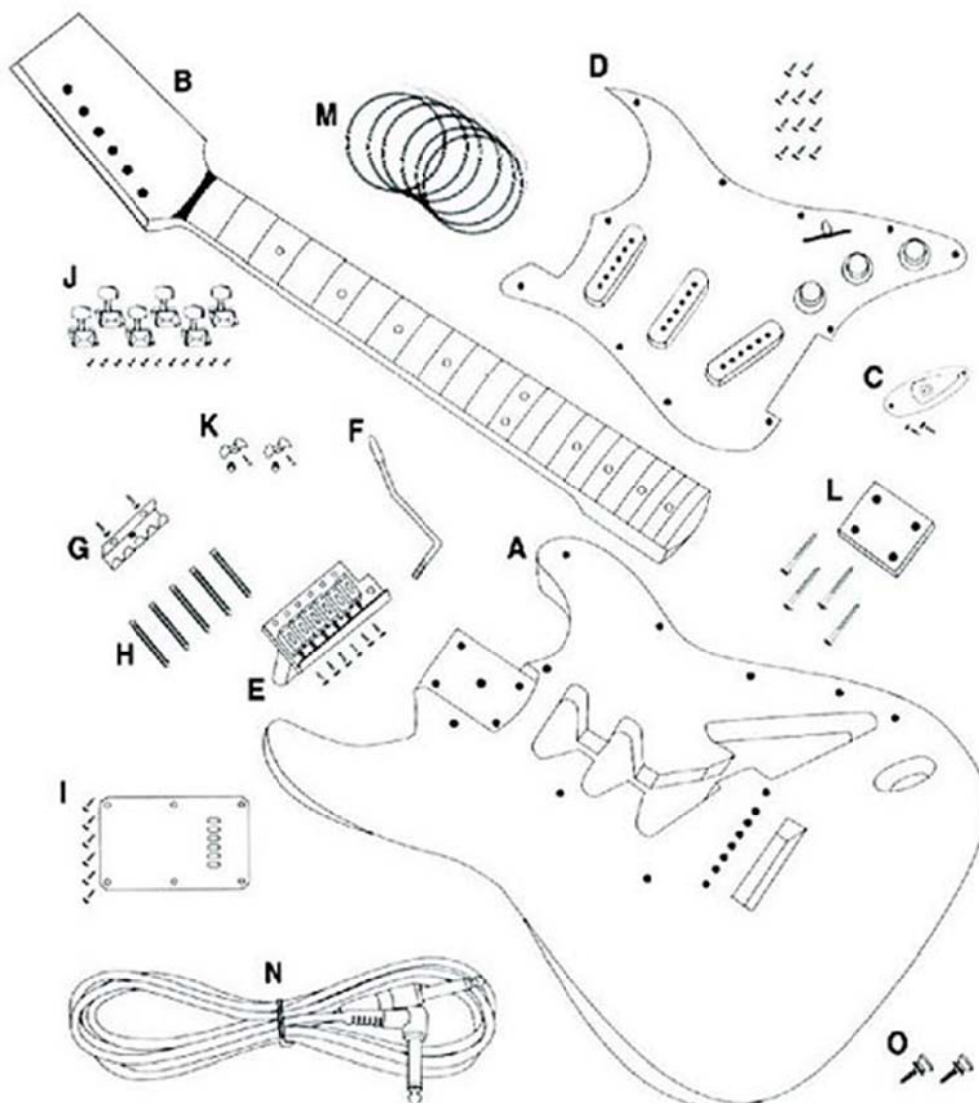

FINISHING THE BODY AND NECK

Although the overall tone and playing characteristics of the instrument will not be affected, a high quality finish is a real source of pride to the builder. Both the neck and body of your Electric Guitar Kit have been sanded and are ready for final sanding and then finishing.

FINISHING THE BODY

First you will need to decide whether you would like a natural finish or a coloured finish on the body. For a natural finish, go directly to "Clear Coat".

COLOR COAT

For the colour coat your first stop is a shop that specializes in automotive products. The **acrylic lacquer** made by the automotive industry is particularly well suited to your needs. In addition to providing a full range of colour choices, acrylic lacquer is extremely durable and resistant to cracking.

Choose your colour from the many available shades (including metallic options) used for automobile touch up work. A spray can will make your job much easier and will produce great results.

- Hang the body as shown in *Figure 1*. Begin each spray stroke in the air on one side of the body and continue until you reach the air on the other side. Overlap each stroke by one half, and every other stroke spray crosswise, then length wise. This technique will provide an even colour distribution.
- Although lacquer dries quickly, and successive coats may be sprayed in a short period of time, attempts to spray too much in one coat can result in runs or bubbles in the finish. Spraying should not be attempted on excessively humid or rainy days.
- One or two coats of colour should be enough. It should not be necessary to sand between coats unless there are drips, runs or bug feet (!) to be levelled. All exposed surfaces should be dead level and have a nice satin gloss.

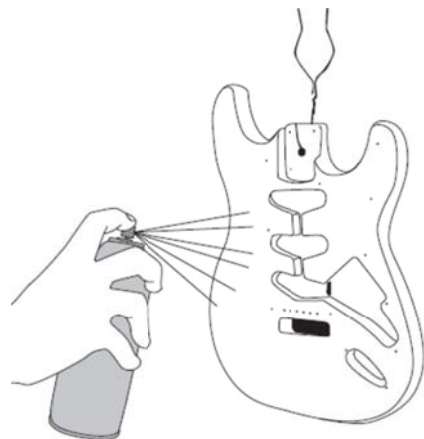

Figure 1

CLEAR COAT

The clear lacquer topcoat is also available at most auto parts stores. If you have applied a colour coat, it is advisable to select the same brand of clear lacquer to assure compatibility.

- The clear coat is applied to the body using the same technique as described for the colour coat. Two or three coats of clear should be adequate.
- For best results the body finish should be allowed to harden for one week before the final cut and polish.

Note: The Bindery on the guitar body must be taped off to prevent overspray from the finish. To avoid runs and drips, hold the spray can 6-10 inches from surface. For best results follow directions on spray can.

Caution: Remember that spray paint is extremely flammable. Do not spray near open flames, heat or sparks. The area where you spray must be well ventilated while spraying

and until all vapour is gone. Do not smoke! Do not breathe the vapour and keep doors and windows open during application and drying.

SHAPING THE HEADSTOCK

The headstock has been left extra long and here is a chance to express your individuality and to make a guitar that is truly your own. First, decide on the shape of the headstock that you would like to use and draw the outline on the top of the headstock.

Using a bandsaw or simple coping saw, cut out the shape of your headstock (see *Figure 2*). A half round file should be used to level the top edge of the headstock. Finally, the edge should be sanded smooth with fine 400 grit sandpaper.

Note: Some headstock shapes are protected by trademark restrictions and we do not recommend that you use them.

NECK

Before application of finish, the fingerboard should be masked off to prevent finish from adhering to the fretted surface (see *Figure 3*). A screw can be inserted temporarily in one of the four holes at the heel which will later be used for attaching the neck to the body. Secure a wire or cord to that screw so that the neck can be hung during spraying.

Spray all exposed surfaces evenly. The neck of your Guitar has been sanded level so it should not be necessary to sand between coats unless runs, orange peel or drips appear. Use the same procedure that you followed on the body – again, two or three coats should do the job. The face of the headstock is traditionally finished black. The final cut and polish takes place about one week later when the lacquer has cured.

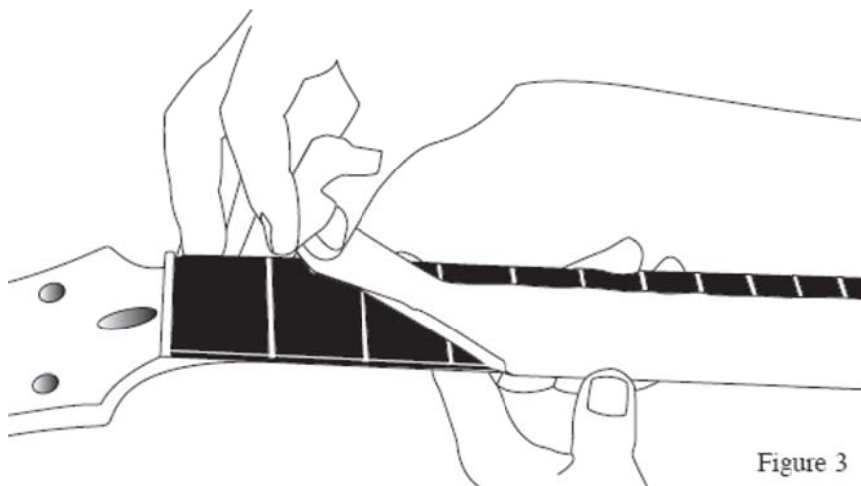

Figure 3

FINAL RUBBING AND POLISHING

After allowing the clear lacquered surfaces to dry and harden for at least one week, sand lightly with non-loading 400 grit sandpaper (commonly known as “wet and dry”). During sanding be sure to place a firm material behind the sandpaper. A large rubber eraser works fine. The eraser is flexible enough to sand the gradual curves but is stiff enough to

prevent the sharper edges (of the headstock, for example) from being rounded off. Be sure to sand with the grain of the wood.

- All sanded surfaces should now be a bit dull, indicating that the finish is flat and level. Now repeat the sanding process with very fine 600 grit sandpaper using water and a small amount of dishwashing detergent as a lubricant. This will remove any sanding marks left by the previous step and leave all surfaces a dull gloss.
- The finish may now be rubbed out using a medium grade automotive rubbing compound (DuPont White Polishing Compound for example). The compound should be used sparingly with fairly good pressure at first — as a high gloss develops, pressure should be diminished. An extra fine grade of polishing compound may be used to get that final bit of gloss. If instructions have been followed you should now have a professional quality finish. You can protect your work with a light wax — Guitar Polish is a good choice.

ASSEMBLING THE GUITAR

1. PICKGUARD ASSEMBLY (PART D)

The three wires from the pickguard assembly must be connected to the three wires that you have already fed into the pickup cavity. Each wire has a mini plug in its end. First slide back the shrink tubing and plug white to white, black to black and blue to blue (See Figure 5). Carefully slide the shrink tubing over the connectors and heat the tubing with a match to permanently seal the connection. Attach the pickguard assembly to the body with the screws provided.

Note: The pickguard has been covered with a clear plastic film to protect it from scratches during transit and assembly. It should be removed after the guitar has been assembled.

2. OUTPUT JACK (PART C)

The cavity for the output jack is located on the lower right hand side of the body. The two wires or two ends of the dual core wire (depending on which one you have) from the pickguard must be fed through the hole that is between the pickguard cavity and the output jack cavity then they are to be connected to the output jack. The “hot wire” which is the wire with a plastic shield around it is to be soldered to the terminal that is for the TIP of the guitar lead. The “ground wire” is to be soldered to the terminal that connects the main shaft of the guitar lead. (see the provided wiring diagram).

After the soldering has been done, use the two screws that have been provided to screw the output jack plate to the body of the guitar.

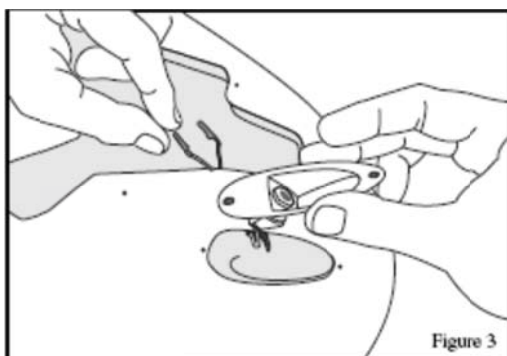

3. SPRING CLAW (PART G)

Turn the body over and attach the spring claw, connect by soldering the spring claw to the ground wire which should be directed through hole in the cavity so that it enters the pickup cavity.

Note: Most players prefer to leave the two screws quite loose in order to have more relaxed spring tension-more about that later during set up. This can be adjusted later.

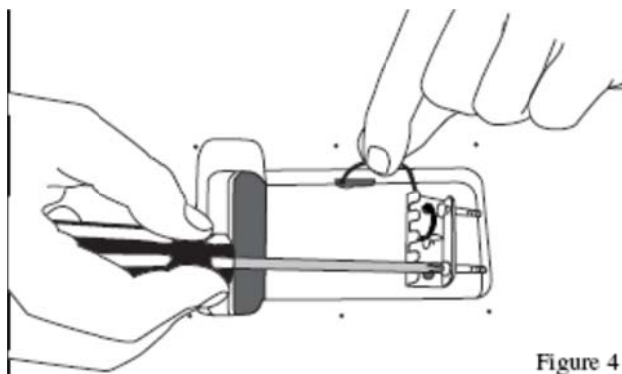

Figure 4

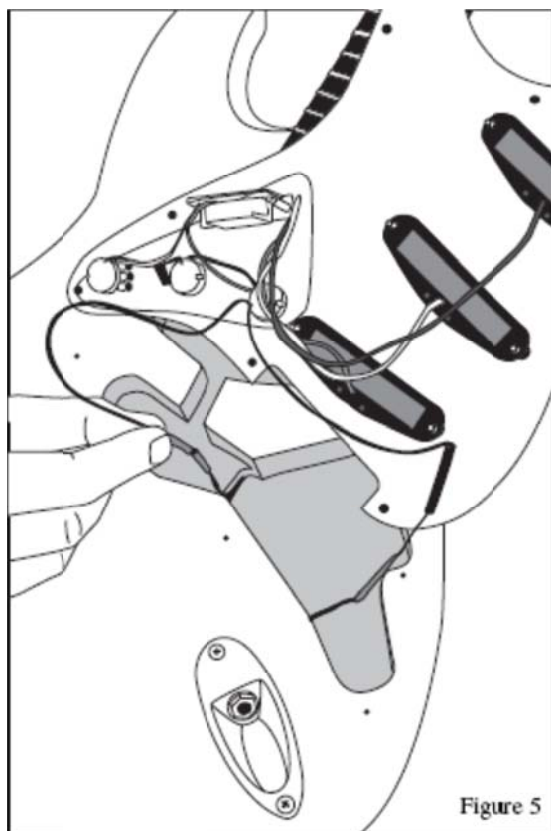

Figure 5

4. TREMOLO UNIT (PART E)

- (1) Attach the tremolo unit using the six screws provided. Do not over tighten.
- (2) Attach springs between the spring claw and the tremolo block – most players use 3 springs only.
- (3) Screw the tremolo arm into the tremolo unit.

5. BACKPLATE (Part I)

Attach the backplate to cover the spring cavity. This step is optional. Many players leave this plate off in order to easily access the tremolo block —especially for changing strings. It is up to you whether you want to put it on or not.

6. STRAP BUTTONS (PART O)

There are two chrome strap buttons. One is screwed onto the butt of the guitar and the other onto the left horn of the body. Insert the screw into the Strap Button then through the hole of the black rubber Strap Button Pad and screw to the body of the guitar.

ASSEMBLING THE NECK

TUNERS (PART J)

Push the six bushing into the washers then into the holes in the face of the headstock then attach the 6 tuners using the 6 screws provided.

STRING TREE (PART K)

The string tree is now attached to the peg-head. (see figure 6) Locate the small hole in the face of the peghead about 3 inches above the string nut. Slip the string notches onto the screw followed by the round cylindrical spacer.

The string tree pulls the first and second strings of the guitar downward. That down-ward pressure will keep the strings from popping out of the nut slots while you are playing. We recommend doing this once the strings are on so you can line up the string trees directly over the strings.

NECKBODY ATTACHMENT

We will now attach the neck to the body using the four large screws. The neck plate acts as a large washer and covers the locator hole on the back of the body.

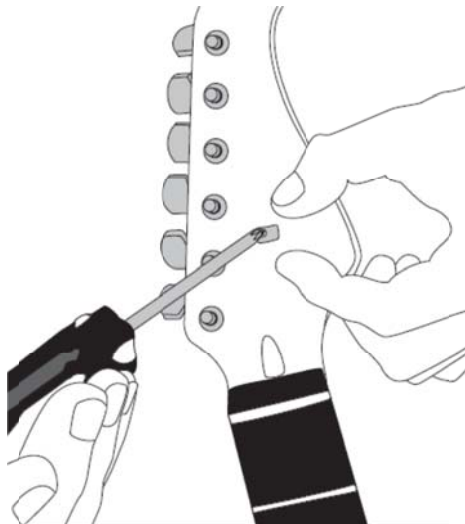

SET UP

STRINGS (PART M)

Put on the strings and tune to pitch.

1. TREMOLO ADJUSTMENT

If the tremolo leans forward and rests against the body adjust the spring plate using the two screws holding it to the body to increase or decrease tension on the springs. This floating tremolo system should be parallel to the body at rest.

2. TRUSS ROD ADJUSTMENT

The adjustable truss rod in the neck of your Guitar has been shop adjusted and should not require any change. If the neck should develop a dip or hollow spot over time it can be removed by tightening the truss rod adjustment nut that protrudes from the base of the headstock just above the nut.

A "back bow" or "hog-back" can be removed by loosening the nut. Great care should be taken with truss rod adjustments where as little as 1/4 of a turn can vastly alter the shape of a neck. A broken truss rod of course means a costly replacement.

2. STRING ACTION

The string "action" refers to the height of the strings above the frets. If the action is too low, the strings will buzz on the frets. If it is too high the guitar will be difficult to play.

3. ACTION AT THE NUT

Setting the string action that is right for you starts at the string nut. The slots at the string nut should already be close to perfection but you might want to make some adjustment. Here's how to do it!

Push the sixth string down between second and third fret. The space between the top of the first fret and the bottom of the string should be about .006" or just about the thickness of the paper that these instructions are printed on. If the gap is wider than .006" you should deepen the slot with a small needle file until it is correct. **DO NOT FILE TOO DEEP!** If the slot is too deep you can fill the slots with a mixture of white plastic sanding dust and crazy glue and then re-shape the slot. Repeat this same procedure for the other five strings. The action at the nut is either right or wrong; it is not a matter of personal preference.

Now let's adjust the height of the strings over the 12th fret. Adjustments to the string action are made by raising or lowering the Tune-o-Matic Bridge with the thumbwheel height adjusters. Following is a chart to assist you. This action adjustment is a matter of personal reference. There should be a gradual increase in height from the first to the sixth string.

String Height at the 12 th fret		
	First String	Sixth String
Low Action	1/32"	1/16"
Medium Action	1/16"	3/32"
High Action	3/32"	1/8"

Action can also be adjusted by changing the angle of the neck. This can be done by inserting small shims between the neck and the body to increase or decrease the neck angle.

4. INTONATION

The saddles on the bridge can be adjusted to compensate for the pitch modification that occurs when the string is stretched as it is fretted. This adjustment is made by tightening or loosening the set screws at the rear of the bridge (see *Figure 7*). Start by tuning your guitar and sounding a harmonic chime directly above the twelfth fret on the sixth string. Now fret the sixth string at the twelfth fret and compare that pitch to the harmonic. If the fretted note is higher than the harmonic tighten the set screw to lengthen the string. If the fretted note is lower than the harmonic, loosen the set screw to shorten the string length. When the harmonic and the fretted note sound the same note, the saddle is at the correct position. Repeat this procedure for the other five strings.

5. PICKUP HEIGHT

Each single coil pickup is adjustable on the bass and treble sides. Finding the best combination of tone and volume will require some experimentation. A good place to start is to adjust the pickup height so that the first string is about 18 over the pickup pole and the sixth string is about 316 over its pole.

Electric Guitar setup is an art in itself. For more detailed discussion we highly recommend that you go onto the internet and search on "electric guitar setups".

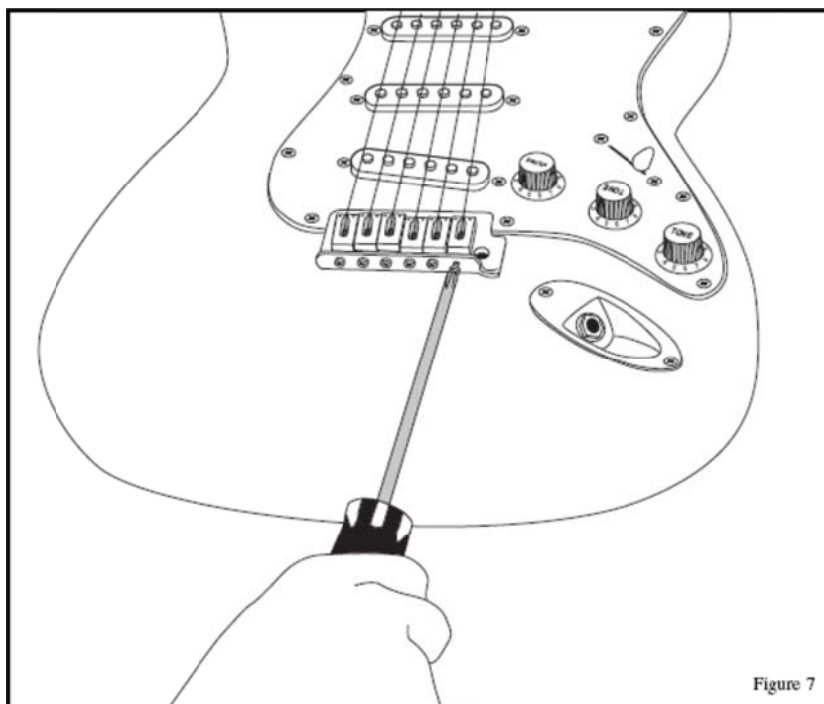
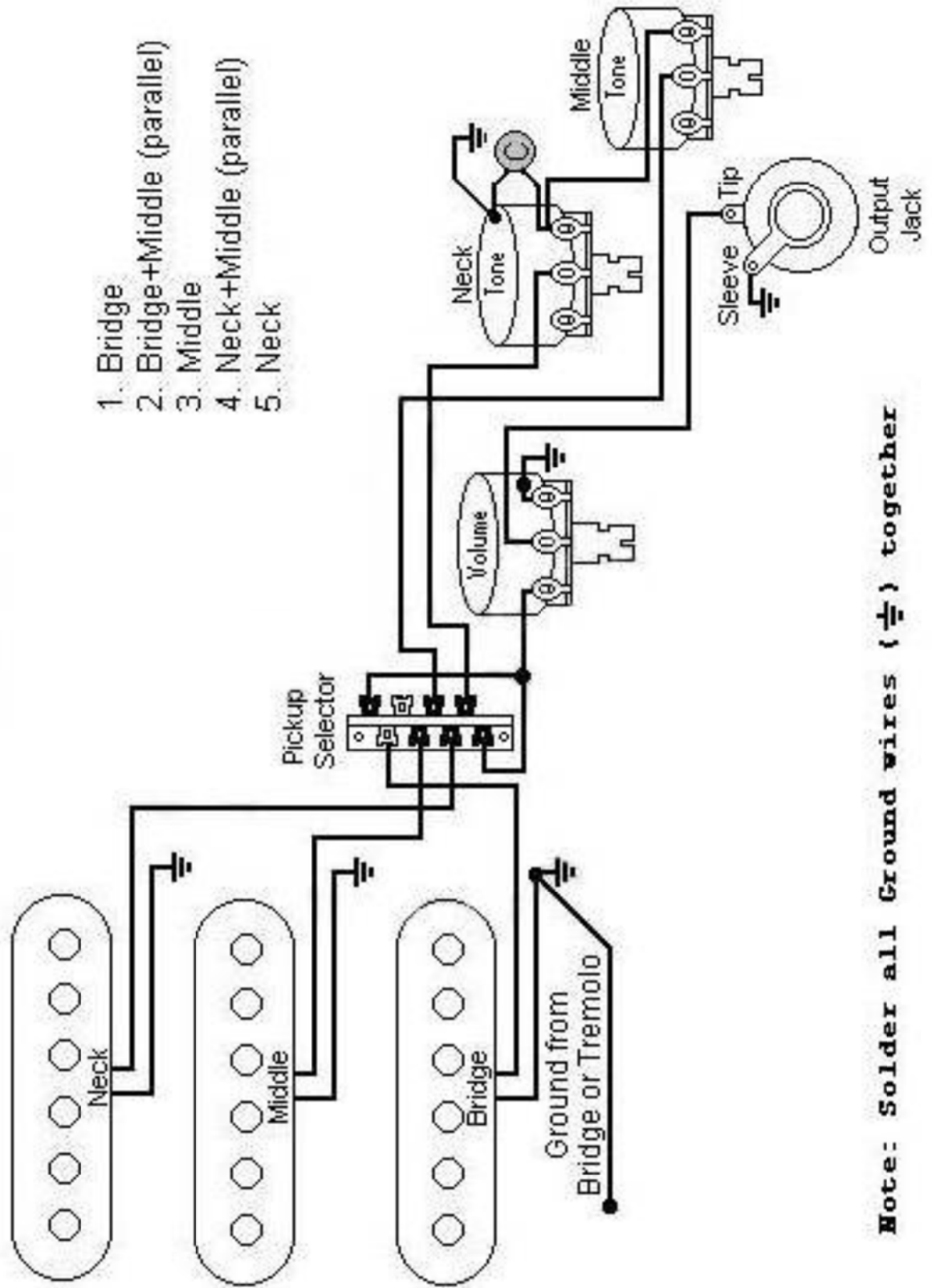

Figure 7

3 Single Coils w/ 1 Volume & 2 Tones

w/ 5-way lever switch



1. Bridge
2. Bridge+Middle (parallel)
3. Middle
4. Neck+Middle (parallel)
5. Neck

Note: Solder all Ground wires (⏏) together